



2015

Computer Hardware: Hardware Components and Internal PC Connections

Jerome Casey

Dublin Institute of Technology, jerome.casey@dit.ie

Follow this and additional works at: <http://arrow.dit.ie/schmultidissoft>



Part of the [Engineering Education Commons](#)

Recommended Citation

Casey, J. (2015). *Computer Hardware: Hardware Components and Internal PC Connections*. Guide for undergraduate students. Dublin Institute of Technology

This Other is brought to you for free and open access by the School of Multidisciplinary Technologies at ARROW@DIT. It has been accepted for inclusion in Instructional Guides by an authorized administrator of ARROW@DIT. For more information, please contact yvonne.desmond@dit.ie, arrow.admin@dit.ie, brian.widdis@dit.ie.



This work is licensed under a [Creative Commons Attribution-Noncommercial-Share Alike 3.0 License](#)



Higher Cert/Bachelor of Technology – DT036A Computer Systems

Computer Hardware – Hardware Components & Internal PC Connections:

You might see a specification for a PC ¹ such as "*containing an Intel i7 Hexa core processor - 3.46GHz, 3200MHz Bus, 384 KB L1 cache, 1.5MB L2 cache, 12 MB L3 cache, 32nm process technology; 4 **gigabytes** of RAM, ATX motherboard, Windows 7 Home Premium **64-bit** operating system, an Intel® GMA HD graphics card, a 500 **gigabytes** SATA hard drive (5400rpm), and WiFi 802.11 bgn*". This section aims to discuss a selection of hardware parts, outline common metrics and specifications used to describe them, what they measure as well as their operation.

POWER SUPPLY:.....	2
HEAT SINKS/FANS:	3
CASE:	5
MANUFACTURERS: ASUS, FOXCONN MOTHERBOARD:	5
MOTHERBOARD:.....	6
EXPANSION CARDS:	9
RAM MEMORY:.....	11
CACHE MEMORY:	13
REGISTERS:.....	15
BIOS:.....	15
BOOT-UP PROCESS:.....	16
CHIPSET:	17
PCI BUS:	19
AGP BUS:	20
PCI EXPRESS 1.0 BUS:	20
(IDE) ATA INTERFACE:	22
SERIAL ATA (SATA):	23

¹ <http://www.tomshardware.com>

Power Supply:

The power supply converts the **alternating current** (AC) from your mains (110V input or 220V input) to the **direct current** (DC) needed by the computer ². In a PC, the power supply is the metal box usually found in a corner of the case. The power supply is visible from the back of many systems because it contains the power-cord receptacle and the cooling fan. Power supplies - often referred to as **switching power supplies**, use switcher technology to convert the AC input to lower DC voltages. The typical voltages produced are: •3.3 volts, •5 volts, •12 volts

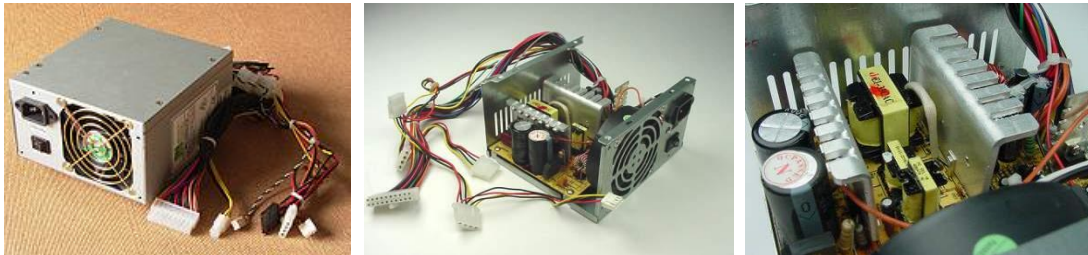

Figures: *left:* A Typical ATX 1.3 power supply. From left to right, the connectors are 20-pin motherboard ³, 4-pin "P4 connector", fan RPM monitor (note the lack of a power wire), SATA power connector (black), "Molex connector", and floppy connector; *middle* and *right:* shows the power supply with three small transformers (yellow) in the center. To the left are two cylindrical capacitors. The large finned pieces of aluminum are heat sinks. The left heat sink has transistors attached to it. These are the transistors in charge of doing the switching -- they provide high-frequency power to the transformers. Attached to the right heat sink are diodes that rectify AC signals and turn them into DC signals.

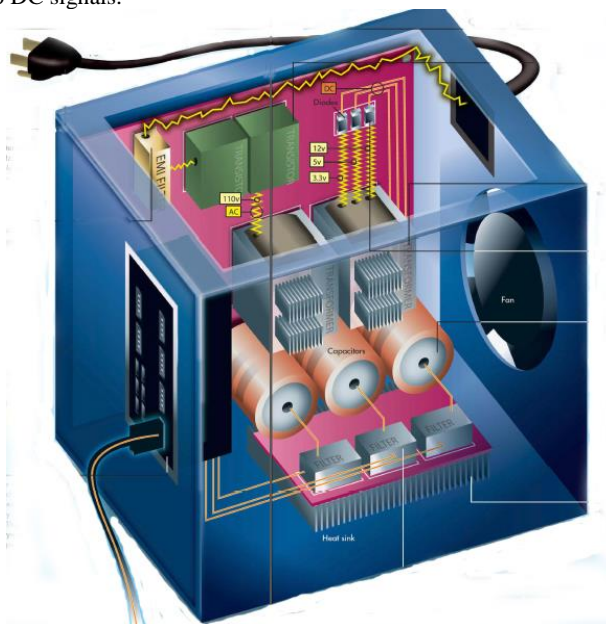

Figure: A power supply schematic showing the AC input, fan, EMI filter (yellow), transformers, cylindrical capacitors, filters, aluminum heat sink, rectifying diodes, and 3 outgoing DC voltage lines. (White, 2008)

The 3.3-volts and 5-volts are typically used by digital circuits, while the 12-volt is used to power fans and motors in disk drives. The main specification of a power supply is in **watts**. A watt is the product of the voltage in volts and the current in amperes or **amps**.

² In a laptop the conversion is done by the AC adapter in the power cable.

³ In current ATX this has changed from 20 pin to 24 pin (2 x12) to support PCI-Express* requirements

The *form factor* of the power supply refers to its general shape and dimensions. The form factor of the power supply must match that of the case that it is supposed to go into, and the motherboard it is to power.

Power Supply Wattage:

A 400-watt switching power supply will not necessarily use more power than a 250-watt supply. A larger supply may be needed if you use every available slot on the motherboard or every available drive bay in the personal computer case. It is not a good idea to have a 250-watt supply if you have 250 watts total in devices, since the supply should not be loaded to 100 percent of its capacity.

According to *PC Power & Cooling, Inc.*, some power consumption values (in watts) for common items in a personal computer are:

Component	Requirement
AGP Video Card	30W - 50W
PCI Express Video	100W - 250W
Average PCI Card	5W - 10W
DVD/CD	20W - 30W
Hard Drive	15W - 30W
Case/CPU Fans	3W (ea.)
Motherboard (w/o CPU or RAM)	50W - 150W
RAM	15W per 1GB
Processor	80W - 140W

If you use a PSU that does not supply enough power for the system, any of the following symptoms might occur:
(i) System does not boot,
(ii) System randomly shuts down,
(iii) Add-in devices do not work properly. *Intel (2014a)*

For overall power supply wattage, add the requirement for each device in your system, then multiply by 1.5. The multiplier takes into account that today's systems draw disproportionately on the +12V output. Furthermore, power supplies are more efficient and reliable when loaded to 30% - 70% of maximum capacity.

Source: http://www.pcpower.com/technology/power_usage

Heat Sinks/Fans:

As processors, graphics cards, RAM and other components in computers have increased in speed and power consumption, the amount of heat produced by these components as a side-effect of normal operation has also increased. These components need to be kept within a specified temperature range to prevent overheating, instability, malfunction and damage leading to a shortened component lifespan. Other devices which need to be cooled include the power supply unit, optoelectronic devices such as higher-power lasers and light emitting diodes (LEDs) and hard disks.

A heat sink is a heat exchanger component attached to a device used for **passive cooling**. It is designed to increase the surface area in contact with the cooling fluid surrounding it, such as the air thus allowing it to remove more heat per unit time. Other factors which improve the thermal performance of a heat sink are the approach air velocity, choice of material – usually an aluminum alloy due to its high thermal conductivity values (229 W/m²K), fin (or other protrusion) design and surface treatment.

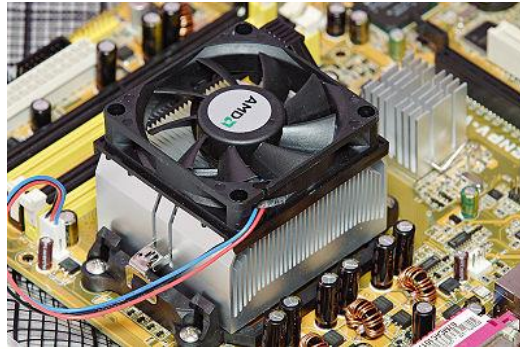

Figures: *Above* A fan-cooled heat sink on the processor of a PC. To the right of it is a smaller heat sink cooling another integrated circuit of the motherboard. *Below* 3 types of Heat-sink design: *Pin*, *Straight* (running the entire length of the heat sink), *Flared*.

The approach air velocity depends on the attached or nearby fan. When there is no air flow around the heat sink, energy cannot be transferred. A computer fan is any fan inside, or attached to, a computer case used for **active cooling**, and may refer to fans that draw cooler air into the case from the outside, expel warm air from inside, or move air across a heat sink to cool a particular component.

Case:

A computer case (also known as a computer chassis, cabinet, box, tower, enclosure, housing, system unit or simply case) is the enclosure that contains most of the components of a computer (usually excluding the display, keyboard and mouse). If you are building your own computer selecting the case will be one of your first choices to make: the type of case, its size, orientation, the number of bays you will need etc.



Figure: shows a stripped ATX desktop case. The motherboard will lie flat on the bottom, against the right panel, with peripheral connectors protruding through the rear panel, drive bays at the top and front, and the power supply at the top and rear.

Sizes

Cases can come in many different sizes (known as **form factors**). The size and shape of a computer case is usually determined by the form factor of the motherboard, since it is the largest component of most computers. Consequently, personal computer form factors typically specify only the internal dimensions and layout of the case.

For example, a case designed for an ATX motherboard and power supply may take on several external forms, such as a *vertical tower* (designed to sit on the floor, height > width) or a *flat desktop* (height < width) or *pizza box* (height ≤ 2 inches, designed to sit on the desk under the computer's monitor). Full-size tower cases are typically larger in volume than desktop cases, with more room for drive bays and expansion slots. *Desktop cases*—and *mini-tower* cases designed for the reduced microATX form factor—are popular in business environments where space is at a premium.

Major Component Locations:

1. The motherboard is usually screwed to the case along its largest face, which could be the bottom or the side of the case depending on the form factor and orientation.
2. Form factors such as ATX provide a back panel with cut-out holes to expose I/O ports provided by integrated peripherals, as well as expansion slots which may optionally expose additional ports provided by expansion cards.
3. The power supply unit is often housed at the top rear of the case; it is usually attached with four screws to support its weight.
4. Most cases include drive bays on the front of the case; a typical ATX case includes a 5.25" bay (used mainly for optical drives) and 3.5" bays used for hard drives, floppy drives, and card readers.
5. Buttons and LEDs are typically located on the front of the case; some cases include additional I/O ports, temperature and/or processor speed monitors in the same area.
6. Vents are often found on the front, back, and sometimes on the side of the case to allow cooling fans to be mounted via surrounding threaded screw holes.

Manufacturers: Asus, Foxconn

Motherboard:

The motherboard is the key circuit board holding the essential processing parts of a computer. It allows all the parts of your computer to **receive power and communicate with one another**. It is usually screwed to the case along its largest face, which could be the bottom or the side of the case depending on the form factor and orientation. The **form factor** describes the shape and layout of the motherboard. It affects where individual components go and the shape of the computer's case. Attached directly to the motherboard are the CPU, RAM, expansion cards, networking, video, and audio components.

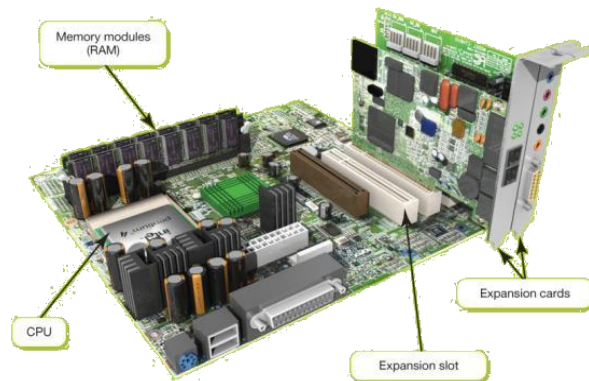

Figures: *Above:* An older motherboard, *Below:* the Intel Z77 motherboard.

ATX (**A**dvanced **T**echnology **e**Xtended) is a motherboard form factor specification developed by Intel in 1995. A full-size ATX board is 12×9.6 in (305×244 mm). It was the first big change in computer case, motherboard, and power supply design in many years, improving standardization and interchangeability of parts. The specification defines the key mechanical dimensions, mounting point, I/O panel, power and connector interfaces between a computer case, a motherboard, and a power supply. The specification has been revised numerous times since 1995, the most recent being version 2.3, released in 2007.

Standards: ATX, standards for smaller boards: microATX, FlexATX and mini-ITX.

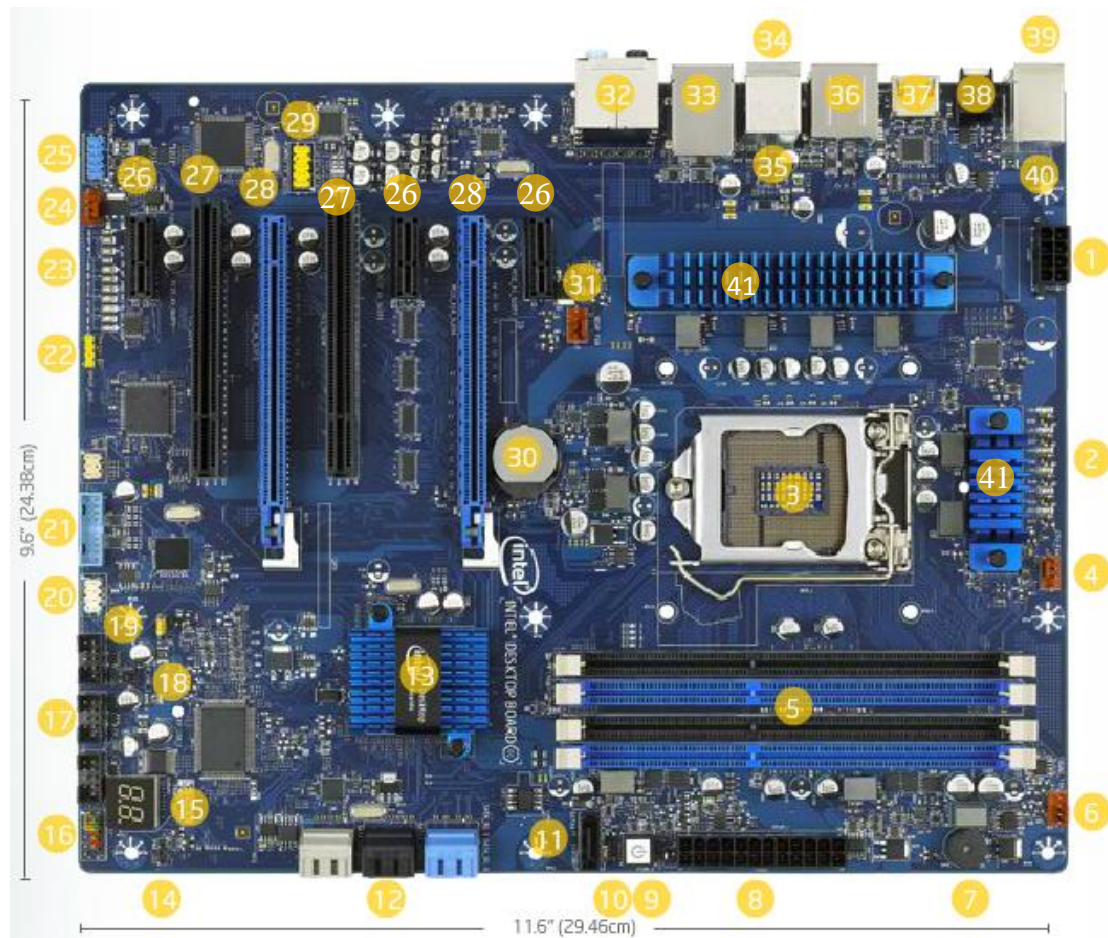

Figure: the Intel Z77 motherboard (Plan View). (Intel, 2014b)

1. 12V Processor Core Voltage Connector (8 pin)	15. POST Code LED Display	29. High Definition (HD) Audio AC97 Front Panel Header
2. Voltage Regulator status LEDs	16. Front Panel Header	30. CMOS RAM Battery
3. Processor Socket (LGA1155)	17. USB 2.0 Dual-Port Header (black)	31. Rear Chassis Fan Header (4 pin)
4. Processor Fan Header (4 pin)	18. Chassis Intrusion Header	32. 5 port audio with S/PDIF
5. Memory Slots	19. BIOS Configuration Jumper	33. Intel Gigabit (10/100/1000 Mb/s) Ethernet LAN
6. Front Chassis Fan Header (4 pin)	20. Consumer IR (CIR) headers	34. IEEE 1394a port
7. Onboard Speaker	21. USB 3.0 Front Panel Connector (blue)	35. External Serial ATA (eSATA) port (3 Gb/s)
8. Main Power Connector (2x12 pin)	22. S/PDIF out Header (4 pin)	36. USB ports: 4 USB 3.0 ports (blue) 2 USB 2.0 ports (black)
9. Onboard Power Button	23. Diagnostic Status LEDs	37. Graphics ports
10. +5V Standby Power Indicator LED	24. Auxiliary chassis fan header (4 pin)	38. Back to BIOS button
11. SATA 3.0 Connector (black)	25. IEEE 1394a front panel header	39. PS/2 port
12. SATA Ports: (4 SATA 6.0 ports (blue & grey) 2 SATA 3.0 ports (black)	26. PCI Express 2.0 x1 connector	40. USB 2.0 ports (yellow) 2 high current/ fast charging ports
13. Intel z77 Express Chipset	27. Conventional PCI bus connector	41. Voltage Regulator modules with heat sinks
14. Alternate Front Panel Power LED Header	28. PCI Express 3.0 x16 connector	

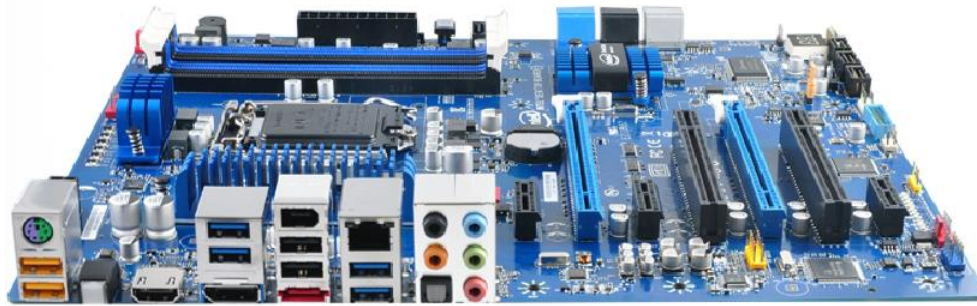

Figure: the Intel Z77 Motherboard (North View).

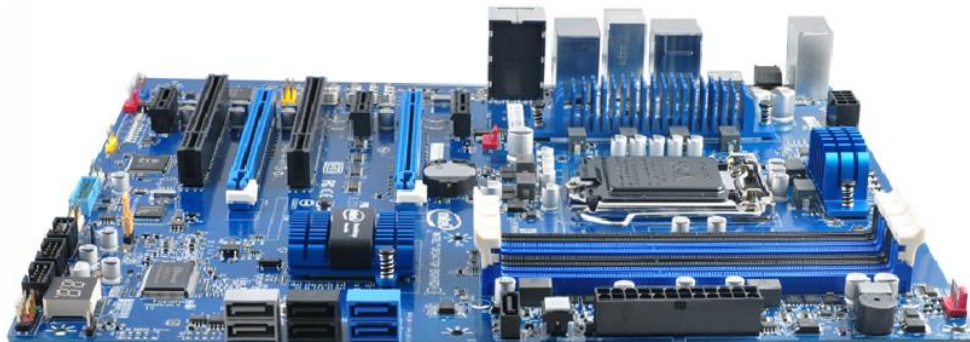

Figure: the Intel Z77 Motherboard (South View).



Figure: the Intel Z77 Motherboard (West View).

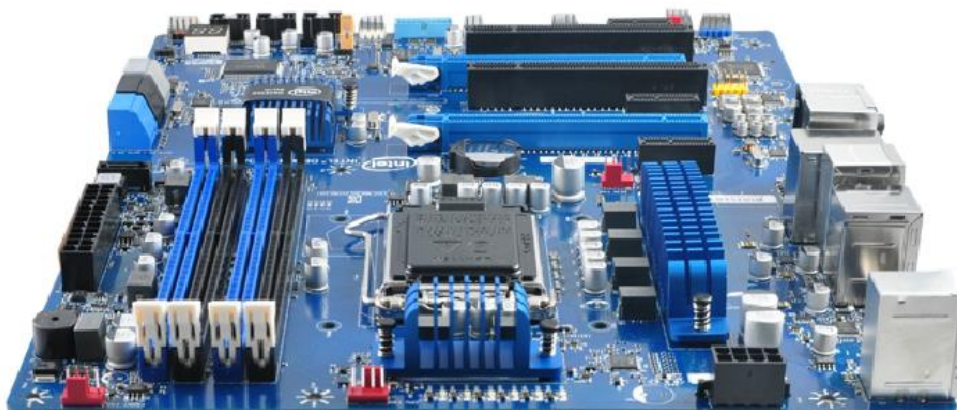

Figure: the Intel Z77 Motherboard (East View).

Expansion Cards:

Special expansion cards are one way to add new types of ports to an older computer or to expand the number of ports on your computer. Like other expansion cards, these cards clip into an open **expansion slot** on the motherboard.

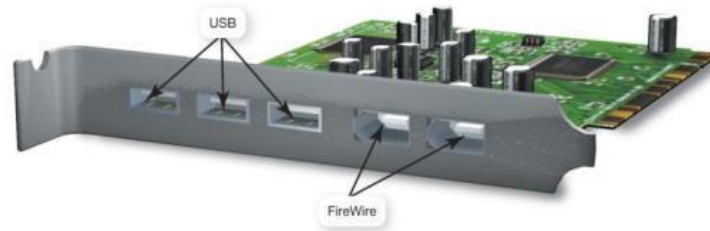

Figure: An expansion card with 3 USB ports and 2 Firewire ports.

Video (Graphics) Card:

A **dedicated** video card (or video adapter) is an expansion card installed inside your system unit to translate binary data received from the CPU or GPU into the images you view on your monitor. It is an alternative to the **integrated** graphics chip.

Modern video cards include ports allowing you to connect to different video equipment; also they contain their own RAM, called **video memory**.

Video cards also come with their own **processors** or **GPUs**. Calls to the CPU for graphics processing are redirected to the processor on the video card, significantly speeding up graphics processing. Updating to a dedicated graphics card offloads work from the CPU and system RAM, so not only will graphics processing be faster, but the system's overall performance will improve.

The video card also controls the number of colors your monitor can display. The number of bits the video card uses to represent each pixel on the monitor (referred to as the **bit depth**) determines the color quality of the image displayed. The more bits available, the better the color detail of the image.

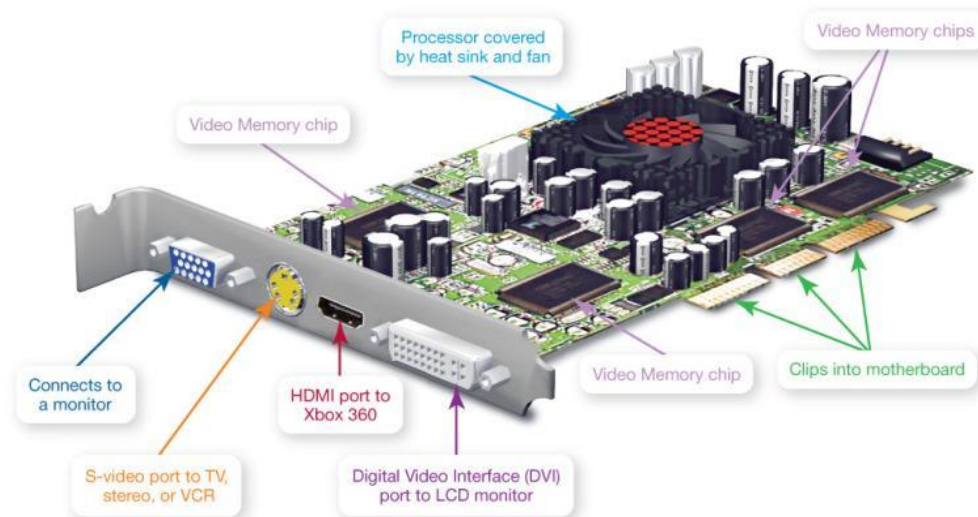

Figure: A Graphics card with output ports for both digital and analog video. The GPU sits under the fan (red) and heatsink.

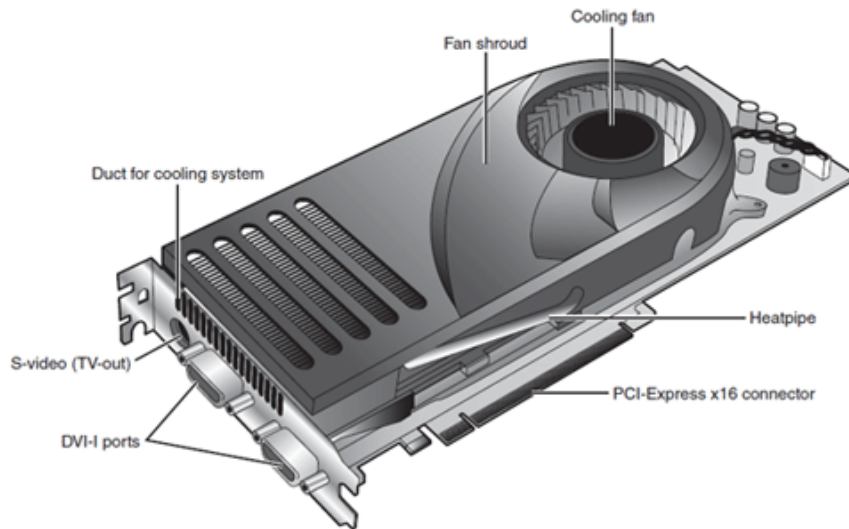

Figure: A mid-range video card optimized for dual-GPU gaming (NVIDIA SLI)

Manufacturers: Nvidia (GeForce ⁴), AMD (Radeon).

Sound Card

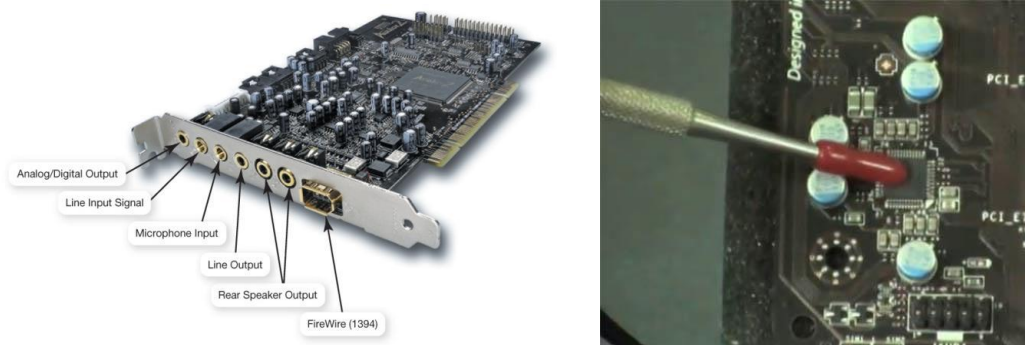

Figure: **Left** An older sound card expansion card. **Right** Sound card module as an integrated circuit on the Z77 motherboard. Indicator is showing the RealTek audio chip. In the bottom right you see the front panel audio connector which would be plugged into the microphone jack and headphone jack on the front of the case.

- Sound cards attached to the motherboard and enabled your computer to record and reproduce sounds.
- Most computers ship with a basic sound card, most often a 3D sound card. 3D sound is better than stereo sound at convincing the human ear that sound is omnidirectional, meaning that you can't tell what direction the sound is coming from. This tends to produce a fuller, richer sound than stereo sound.
- To set up surround sound on your computer, you need two things: a set of surround-sound speakers and a sound card that is Dolby Digital compatible. There are many formats to choose from such as Dolby Digital EX, Dolby Digital Plus, and Dolby TrueHD.

The ports on the sound card allow you to connect additional audio devices such as amplified speakers, headphones, microphones etc.

⁴ The technology demos from Nvidia used to showcase the rendering power of the chip. See YouTube and <http://www.nvidia.com/coolstuff/demos>

Network Card:

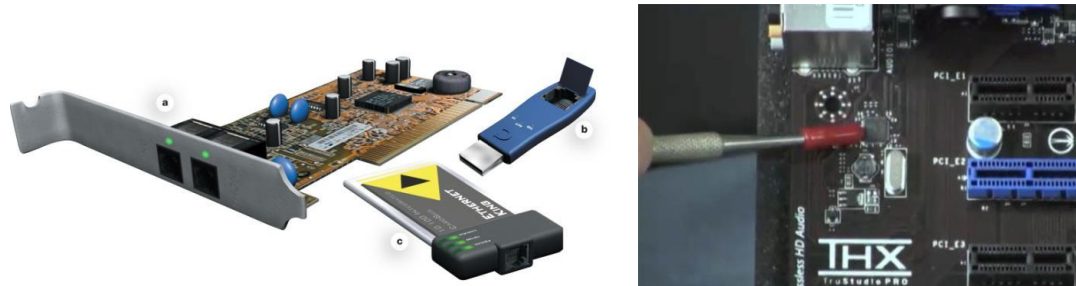

Figure: Left An older Network card expansion card. Right The Gigabit Ethernet Card as a integrated circuit on the Z77 motherboard. The indicator is pointing to the Gigabit Ethernet chip, while just below it is a crystal.

An Ethernet network requires that you install or attach network adapters to each computer or peripheral you want to connect to the network. Most computers come with Ethernet adapters preinstalled as **network interface cards** (NICs).

If your computer doesn't have a NIC, your options are: (i) buy one and install it, or (ii) use a USB adapter, which you plug into any open USB port on the system unit.

RAM Memory:

Random access memory (RAM) is a series of small cards or modules plugged into slots on the motherboard. The CPU can request any data in RAM. It is then located, opened, and delivered to the CPU for processing in a few billionths of a second. Since all the contents of RAM are erased when you turn off the computer, RAM is the temporary or **volatile** storage location for the computer.



Figure: A RAM Memory Module.

Operation:

Similar to a microprocessor, a memory chip is an integrated circuit (IC) made of millions of **transistors** and **capacitors**. In the most common form of computer memory, **dynamic random access memory** (DRAM), a transistor and a capacitor are paired to create a **memory cell**, which represents a single bit of data. The capacitor holds the bit of information - a 0 or a 1. The transistor acts as a switch that lets the control circuitry on the memory chip read the capacitor or change its state.

A capacitor is like a small bucket that is able to store electrons. To store a 1 in the memory cell, the bucket is filled with electrons. To store a 0, it is emptied. The problem with the capacitor's bucket is that it has a leak. In a matter of a few milliseconds a full bucket becomes empty. Therefore, for dynamic memory to work, either the CPU or the memory controller has to come along and recharge all of the capacitors holding a 1 before they discharge. The capacitors must to be energized every **15ms** or so (hundreds of times per second) to maintain their charge. To do this, the **memory controller** reads the memory and then writes it right back. This is **refresh operation** happens automatically and is how dynamic RAM got its name. Dynamic RAM has to be dynamically refreshed all of the time or it forgets what it is holding. The downside of all of this refreshing compared to SRAM is that it takes time and slows down the memory.

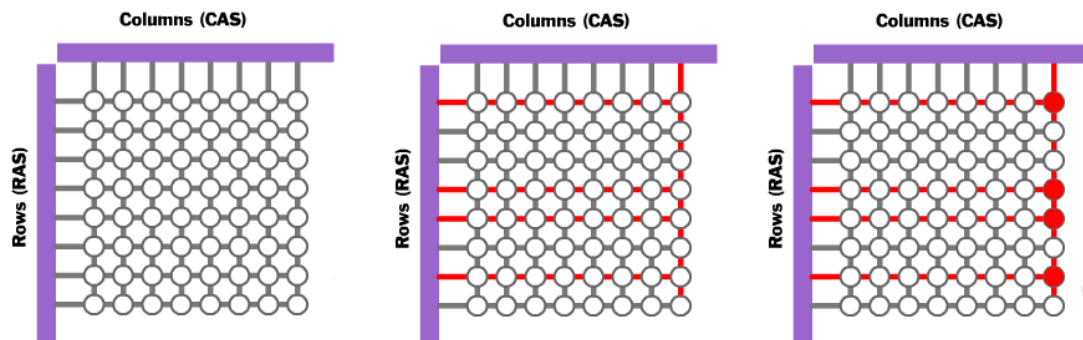

Figure: (a) Empty Memory Cells (0), (b) voltage applied to Column and Row lines (c) 4 cells charged

Memory cells are etched onto a silicon wafer in an array of columns (**bitlines**) and rows (**wordlines**). The intersection of a bitline and a wordline constitutes the **address** of the memory cell.

DRAM works by sending a charge (an electrical signal called a **strobe**) through the appropriate column (CAS) to activate the transistor at each bit in the column. When writing, the row lines contain the state the capacitor should take on. When reading, the **sense-amplifier** determines the level of charge in the capacitor. If it is more than 50 percent, it reads it as a 1; otherwise it reads it as a 0. The **counter** tracks the refresh sequence based on which rows have been accessed in what order. The length of time necessary to do all this is so short that it is expressed in **nanoseconds** (billionths of a second). A memory chip rating of **70ns** means that it takes 70 nanoseconds to completely read and recharge each cell.

Memory cells alone would be worthless without some way to get information in and out of them. So the memory cells have a whole support infrastructure of other specialized circuits. These circuits perform functions such as:

- Identifying each row and column (**row address select** and **column address select**)
- Keeping track of the refresh sequence (**counter**)
- Reading and restoring the signal from a cell (**sense amplifier**)
- Telling a cell whether it should take a charge or not (**write enable**)

Other functions of the **memory controller** include a series of tasks that include identifying the type, speed and amount of memory and checking for errors.

1. When you open an application such as Excel, it is loaded into RAM. To conserve RAM usage, many applications load only the essential parts of the program initially and then load other pieces as needed.
2. After an application is loaded, any files that are opened for use in that application are loaded into RAM.
3. When you save a file and close the application, the file is written to the specified storage device, and then it and the application are **purged** from RAM.

How Much RAM do you need?

The amount of RAM actually sitting on memory modules in your computer is your computer's **physical memory**. The memory that your operating system uses is referred to as **kernel memory**. To determine how much RAM your computer needs, look at the memory requirements for each program and add them up.

- You need RAM for the operating system, application software, and data. If your system responds slowly or accesses the hard drive constantly, then you need to add more RAM

Table: Sample RAM requirements:

Application	Minimum RAM Required
Windows 7	1000 MB
Microsoft Office Professional 2007	256 MB
Internet Explorer 8	128 MB
iTunes	256 MB
Adobe Photoshop Elements	512 MB
<i>Total RAM required to run all programs simultaneously</i>	<i>2,152 MB or 2.15 GB</i>

To save data more permanently, you need to save it to the hard drive or to another permanent storage device such as a CD or flash drive.

Read-only memory (ROM) holds all the instructions the computer needs when it is powered on. The data does not get erased when the power is turned off.

Metrics for RAM speed:

System RAM speed is controlled by bus width and bus speed. **Bus width** refers to the number of bits that can be sent to the CPU simultaneously, and **bus speed** refers to the number of times a group of bits can be sent each second. A **bus cycle** occurs every time data travels from memory to the CPU. For example, a 100-MHz 32-bit bus is theoretically capable of sending 4 bytes of data to the CPU 100 million times per second, while a 66-MHz 16-bit bus can send 2 bytes of data 66 million times per second. If you do the sums, you'll find that simply changing the bus width from 16 bits to 32 bits and the speed from 66 MHz to 100 MHz in our example allows for three times as much data (400 million bytes versus 132 million bytes) to pass through to the CPU every second for processing.

Cache Memory:

Even with a wide and fast bus, it still takes longer for data to get from the memory card to the CPU than it takes for the CPU to actually process the data. Caches are designed to alleviate this bottleneck by making the data that is used most often by the CPU instantly available. This is accomplished by building a small amount of memory, known as primary or **level 1 cache**, right into the CPU. Level 1 cache is very small, e.g. [384 KB L1 cache](#) for the Intel i7 Hexa core.

The secondary or **level 2 cache** typically resided on a memory card located near the CPU with a direct connection to the CPU. A dedicated integrated circuit on the motherboard, the **L2 controller**, regulates the use of the level 2 cache by the CPU. e.g. [1.5 MB L2 cache](#) for the Intel i7 Hexa core. In most systems, data needed by the CPU is accessed from the cache approximately 95 percent of the time, greatly reducing the overhead needed when the CPU has to wait for data from the main memory.

Some inexpensive systems dispense with the level 2 cache altogether. Many high performance CPUs now have the level 2 cache actually built into the CPU chip itself as well as a level 3 cache. Therefore, the size of the level 2 cache and whether it is **onboard** (on the CPU) is a major determining factor in the performance of a CPU.

e.g. 12 MB L3 cache for the Intel i7 Hexa core.

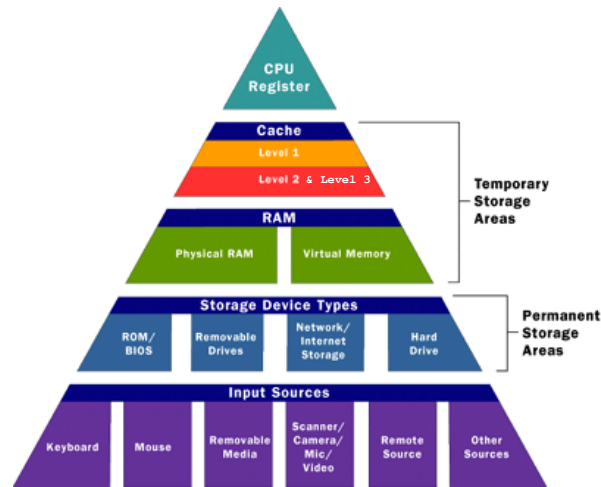

Figure: CPU Memory Access Hierarchy Chart. Level 3 cache is now common.

How Caching Operates:

A particular type of RAM, **static random access memory** (SRAM), is used primarily for cache. SRAM uses multiple transistors, typically four to six, for each memory cell. It has an external gate array known as a **bistable multivibrator** that switches, or flip-flops, between two states. This means that it does not have to be continually refreshed like DRAM. Each cell will maintain its data as long as it has power. This means SRAM can operate extremely quickly, significantly *faster* than dynamic RAM. However the complexity of each cell means it takes up a lot *more space* on a chip and makes it prohibitively expensive for use as standard RAM.

Static RAM is fast and expensive, and dynamic RAM is less expensive and slower. Thus static RAM is used to create the CPU's speed-sensitive **cache**, while dynamic RAM forms the larger system RAM space.

Some principles of cache operation are as follows:

1. Cache technology is the use of a faster but smaller memory type to accelerate a slower but larger memory type, such as RAM.
2. When using a cache, you must check the cache to see if an item is in there. If it is there, it's called a **cache hit**. If not, it is called a **cache miss** and the computer must wait for a round trip from the larger, slower main memory area.
3. A cache has some maximum size that is much smaller than the larger main memory storage area.
4. It is possible to have **multiple cache layers**. In a one-level cache, the Level 1 cache is first checked, if there is a miss, the RAM is searched. In a two-level cache the Level 1 cache is first checked, if there is a miss, the Level 2 cache is checked, if there is a miss, the RAM is searched.
5. Cache is populated using a concept called **locality of reference**. It means that in a fairly large program, only small portions are ever used at any one time. Even if an executable is 10 MB in size, only a handful of bytes from that program are in use at any one time, and their rate of repetition is very high.

Registers:

The final step in memory hierarchy are the registers. These are memory cells built right into the CPU that contain specific data needed by the CPU, particularly the **arithmetic and logic unit (ALU)**. An integral part of the CPU itself, they are controlled directly by the compiler that sends information for the CPU to process.

BIOS:

The **basic input-output system (BIOS)** is the first thing you see when you turn on your computer. The BIOS is special software that interfaces the major hardware components of your computer with the operating system. It is usually stored on a Flash memory chip on the motherboard (which has its own battery), but sometimes the chip is another type of ROM.



Figure: The BIOS chip and the BIOS setup Utility program

The BIOS software has a number of different roles, but its most important role is to **load the operating system**. When you turn on your computer and the microprocessor tries to execute its first instruction, it has to get that instruction from somewhere. It cannot get it from the operating system because the operating system is located on a hard disk, and the microprocessor cannot get to it without some instructions that tell it how. The BIOS provides those **instructions**. Some of the other common tasks that the BIOS performs includes:

1. A power-on self-test (POST) for all of the different hardware components in the system to make sure everything is working properly.
2. Activating other BIOS chips on different cards installed in the computer – e.g. SCSI and graphics cards often have their own BIOS chips.
3. Providing a set of low-level routines that the operating system uses to interface to different hardware devices - it is these routines that give the BIOS its name. They manage things like the keyboard, the screen, and the serial and parallel ports, especially when the computer is booting.
4. Managing a collection of settings for the hard disks, clock, etc.

Manufacturers: American MegaTrends Inc. (AMI), Phoenix Technologies, Ali, Winbond.

e.g. say you insert more RAM memory → once the module is installed, close the case, plug the computer back in and power it up. When the computer starts the POST, it should automatically recognize the memory.

Boot-Up Process:

A PC cannot do anything useful unless it is running its **operating system** - software that acts as a supervisor for all its software applications. It sets the rules for using memory, drives, and other hardware devices on the computer. Before a PC can run the operating system, it needs some way to load it from disk into RAM. The way to do this is with the **bootstrap** – a small amount of code that is executed on startup or system boot. The bootstrap is aptly named because it lets the PC do something entirely on its own ⁵, without any outside operating system. The boot-up sequence of events is as follows:

1. The computer loads the **basic input/output system** (BIOS) from ROM. The BIOS provides the most basic information about storage devices, boot sequence, security, Plug and Play (auto device recognition) capability and a few other items.
2. The BIOS triggers a test called a **power-on self-test** (POST) to make sure all the major components are functioning properly. You may hear your drives spin and see some LEDs flash, but the screen, at first, remains black.
3. The BIOS has the CPU send signals over the system bus to be sure all of the basic components are functioning. The bus includes the electrical circuits printed on and into the motherboard, connecting all the components with each other.
4. The POST tests the memory contained on the display adapter and the video signals that control the display. This is the first point you'll see something appear on your PC's monitor.
5. During a **cold boot** the **memory controller** checks all of the memory addresses with a quick read/write operation to ensure that there are no errors in the memory chips. Read/write means that data is written to a bit and then read back from that bit. You should see some output to your screen - on some PCs you may see a running account of the amount of memory being checked.
6. The computer **loads the operating system** (OS) from the hard drive into the system's RAM. That ends the POST and the BIOS transfers control to the operating system. Generally, the critical parts of the operating system - the **kernel** - are maintained in RAM as long as the computer is on. This allows the CPU to have immediate access to the operating system, which enhances the performance and functionality of the overall system.

See more on POST Codes Ranges, the operation that corresponds to the code and the POST sequence at <http://www.intel.com/support/motherboards/desktop/sb/CS-025434.htm>

⁵ The origin of the word “boot up” comes from the concept of lifting yourself up by your bootstraps.

Chipset:

The PC has become so complex that even the most recent, powerful processors can't do the entire job of managing the flow of data by themselves. The CPU has been given help in the form of the **chip set**, located nearby on the motherboard. The chip set traditionally consisted of two microchips, often referred to as the **North Bridge** and the **South Bridge**, that acted as the administrators to the CPU, or chief executive. The chip set bridged logical and physical gaps between the CPU and other chips, all the time watching and controlling the input and output of specific components. The exact function of the chip set is constantly changing.

In 2003 AMD introduced the AMD Athlon 64 bit chip, where the CPU reclaimed some of the memory controller functions of the North Bridge. Intel later also adopted this architecture with their core i-series of processors.

But in all cases, the bridges determine what kinds of memory, processors, and other components can work with that particular motherboard. There is now a trend to replace the names North Bridge and South Bridge with less elegant terms such as **Graphics Memory Controller Hub (GMCH)** and the **I/O Controller Hub (ICH)**, even though their basic purpose is the same.

Where a motherboard still has the older architecture you can distinguish the **North Bridge** because it resides as close as possible to three other components that are connected to this chip: the **CPU**, the **memory**, and the **graphics port**. Even though connections are at the speed of light, their proximity on the motherboard does make a difference. When you're counting in nanoseconds (billionths of a second) 'small differences' are significant. When the CPU needs data from RAM, it sends a request to the North Bridge **memory controller**⁶. The controller, in turn, sends the request along to memory and tells the CPU how long the processor must wait to read the memory over a speedy connection called the **front side bus (FSB)**. The remaining connection of the North Bridge is to the South Bridge.

The **South Bridge** primarily handles the routing of traffic between the various input/output (I/O) devices on the system for which speed is not vital to the total performance, such as the disk drives (including RAID drive arrays), optical drives, PCI-Express devices, the older PCI bus, and the USB, Ethernet, and audio ports. It is also responsible for less prominent input/output, such as the real-time clock, interrupt controller, and power management. The remaining slowcoaches of the computer - the keyboard, the serial ports, and the mouse - are handled by a separate device called the **SIO** or **super input/ output**.

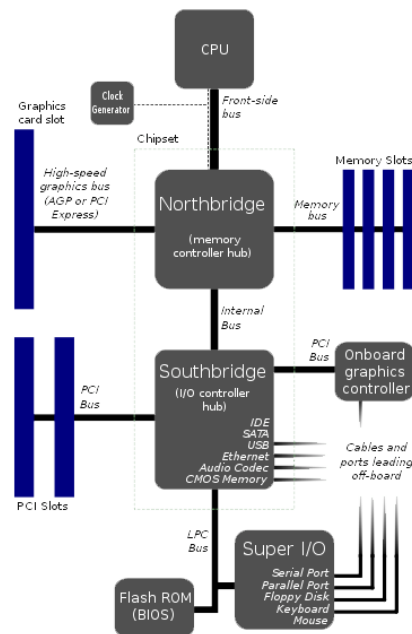

Figure: A Block Diagram showing the Bus Systems between components on the Motherboard.

⁶ The memory controller also constantly renews the memory modules (RAM). Since the charge begins to dissipate as soon as it's created, the bridge's memory controller endlessly, thousands of times a second, reads each of the millions of cells and writes back the values it read.

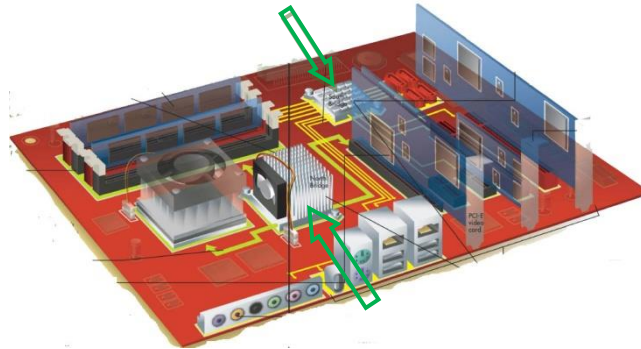

Figure: the Motherboard with the North Bridge and South Bridge highlighted on an older motherboard



Figure: the Z77 Motherboard – the i-series CPU has made the NorthBridge chip obsolete.

Intel® Z77 Express Chipset Block Diagram

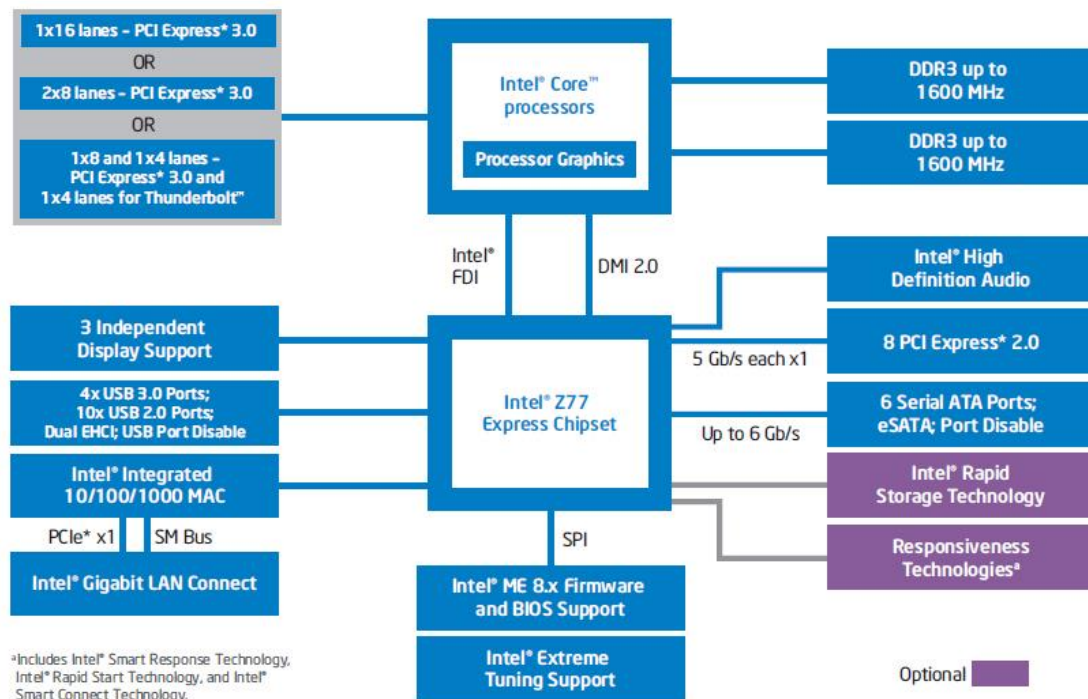

Figure: Intel z77 Express Chipset Block Diagram

PCI Bus:

The **Peripheral Component Interconnect (PCI)** bus produced by Intel in 1992 provided direct access to system memory for any connected hardware devices.



Figure: PCI slots on a motherboard.

This bus allowed multiple packets of information from different sources to travel down it simultaneously. Previously it was used to connect to the graphics card and this setup meant that information from the graphics card travelled through the bus along with any other information coming from a device connected to the PCI. When all the information arrived at the CPU, it had to wait in line to get time with the CPU. This system worked well for many years, but eventually the PCI bus could not keep up. The Internet and most software were more and more graphically oriented, and the demands of the graphics card needed priority over all other PCI devices.

This is now a **legacy** technology and is used for functions that do not require great quantities or speed in data transmissions. PCI slots were mainly used for network, graphics and sound cards.



Figure: PCI card showing the pins (4+2+24+10+8+2) and PCI bridge chip.

PCI cards use 47 pins to attach to a PCI slot. Pins are thin metal feet that allow computer chips to be attached to a circuit board. AGP replaced the PCI as the standard way to connect a graphics card to the motherboard.

AGP Bus:

In 1996, Intel introduced AGP as a more efficient way to deliver streaming video and real-time-rendered 3-D graphics that were becoming more prevalent in all aspects of computing to and from the CPU. Previously, the standard method of delivery was the PCI bus.



Figure: an AGP based graphics card.

AGP is based on the design of the PCI bus; but unlike a bus, it provides a **dedicated point-to-point connection** from the graphics card to the CPU. With a clear path to the CPU and system memory, AGP provided a much faster, more efficient way for a computer to get the information it needed to render complex graphics.

An AGP, or **accelerated graphics port**, allowed the operating system to designate RAM for use by the graphics card on the fly.

AGP started with a bandwidth of **266 MB/s**; AGP 2x -> **533 MB/s**; AGP 4x -> **1066 MB/s**; AGP 8x -> **2133 MB/s**. However, AGP then became overtaken by the newer PCI-Express slots, which come in several denominations to make them the do-all, fit-all slot for every expansion board, not just graphics.

PCI Express 1.0 Bus:

PCI Express or PCIe began to appear in 2004 and eliminates the need for the AGP by accepting more data and supplying more power to video cards. By early 2006, most motherboards featured PCI x16 slots (4,000MB/s) in place of AGP 8x.

The shorter ones (shown below) are **x1 PCIe** slots and are common to all PCI Express slots. PCI-Express slots will also accept older PCI cards. To handle graphics and sound data faster, the PCIe slot can be expanded to **x2**, **x4**, **x8**, or, **x16** slots, where the numbers represent multiples of the speed of an **x1** PCIe slot. Their ability to move data is indicated by the multiplier factor in their designations.

New computer applications, such as streaming video and photo editing, put new demands on PCs to move vast amounts of data ever quicker. Even the fastest of them, AGP 8x, which spewed out **2.133 GB/s**, was not good enough for the demands of real-time-photorealistic animation that needs values for the colors of millions of pixels pushed through the circuits 60 times or more each second. The solution is a bus architecture that uses both parallel and serial transfers.

Operation:

A PCI-Express bus breaks all data (payload) it handles into pieces and wraps the pieces in a **packet**. The packet includes other binary codes that identify where the information has come from, its destination, its sequence among all the other packets being sent, and the results of a **cyclic redundancy check (CRC)**. A CRC is a mathematical operation that detects transmission errors in the data.⁷

e.g. 8b/10b means **8 bits of data transferred for every 10 bits sent**

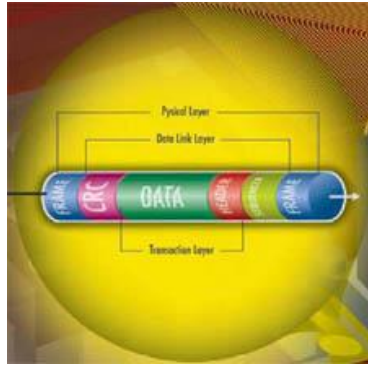

Figure: A Packet and its constituents: Frame Number, CRC, Data (Payload), Header, Footer.

After subtracting the overhead for packet packaging, the basic PCI-Express x1 slot has a top bandwidth of 250 Megabytes a second (MB/s). But PCI-E is scalable. Devoting two or more lanes to send data to and from a single component - called **channel bonding** - increases the bandwidth for each lane added to the channel. PCI-E transfers data at **250 MB/s** in **each direction per lane**. A lane is composed of two differential signalling pairs: one pair for receiving data, the other for transmitting. Thus, each lane is composed of four wires or signal traces.

With a maximum of 32 lanes, PCI-E 1.0 allows for a total combined transfer rate of **8 GB/s** in each direction. That gives a single channel nearly twice the bandwidth of the older PCI and an eight lane slot a data rate comparable to the fastest version of AGP. You can identify the expansion slots with the increased bandwidth by comparing the slots' lengths. The basic PCIe **x1** slot is about **24.5mm** long. Each **13.5mm** added to other slots represents another **250MB** added to their bandwidth.

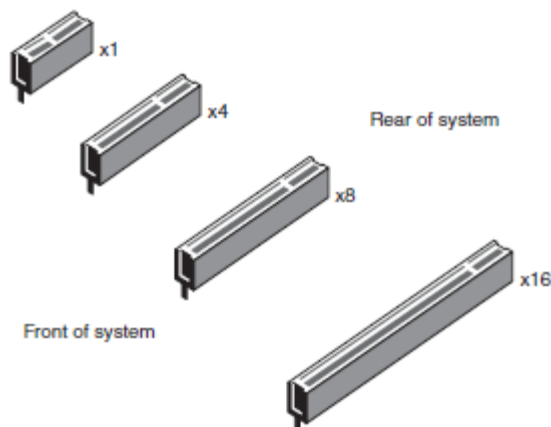

Figure: PCI express x1, x4, x8 and x16 connector slots. x4 and x8 appear mainly in servers.

⁷ Checksum (summation check) – a technique for determining whether a package of data is valid. The package, a string of binary digits, is added up and compared with the expected number.

1. The chipset sends packets serially over two lines. Another pair of lines is responsible for packets going in the opposite directions. Taken together, the two pairs are called a **lane**. One of the lines in each pair carries the original signal. The other line carries a negative image of the signal; each 0 becomes a 1 and each 1 becomes a 0 (**differential signalling**). The lines are laid out so that any electrical noise, or static, that affects one line should also affect the other.
2. When packets reach their destination, the receiver restores the negative packet to its positive version. That same operation reverses the values of any junk signals introduced by electrical interference. The bus combines the two paired packets, and any interference in the original packet is cancelled by its negative image in the matching packet.
3. It also performs the same CRC operation that was performed on the packet before its journey and compares its result to the earlier one bundled into the packet. If CRCs differ, the bus orders the packet be re-sent. Since the sequence of the data in each packet is included in the packet, the bus doesn't have to wait for the corrected packet. It can continue to accept other packets and then put them all back in the correct order when all the packets have been received.

PCI Express Version	Bandwidth *	Bandwidth ‡	Encoding	Year Released
1.0	250MB/s	(2 GB/s)	8b/10b	2002
2.0	500MB/s	(4 GB/s)	8b/10b	2007
3.0	1000MB/s	(~ 8 GB/s)	128b/130b	2010

* Per lane, in each direction ‡ Per 8 lanes, in each direction

(IDE) ATA Interface:

Usually, these devices connect to the computer through an **Integrated Drive Electronics (IDE)** interface. Essentially, an IDE interface is a standard way for a storage device to connect to a computer. IDE is actually not the true technical name for the interface standard. The original name, **AT Attachment** (ATA) or parallel ATA, signified that the interface was initially developed for the IBM AT computer. We will learn about the evolution of IDE/ATA, what the pinouts are and exactly what “slave” and “master” mean in IDE.

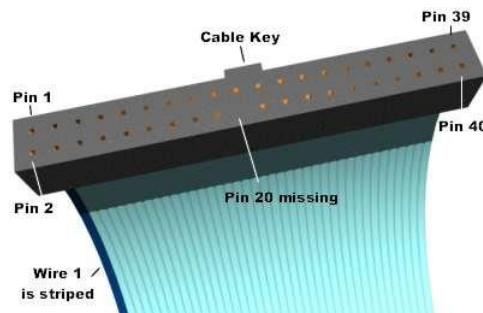

Figure: *Left* A close-up of the primary and secondary IDE interfaces on a motherboard; *Right* The connector on an IDE cable, the stripe denotes where to align with Pin 1.

IDE quoted upper transfer rates of 133MB/s. Above that, crosstalk, or electrical interference, from their 40-wire parallel cables drowns out meaningful communication.

Serial ATA (SATA):

Serial ATA was designed to replace the older parallel ATA (PATA) standard (often called by the old name IDE), offering several advantages over the older interface:

1. reduced cable size (7 conductors compared to 40 with the wider PATA ribbon cable) – which facilitates a more efficient airflow inside a form factor and also allows for smaller chassis designs as well as a reduced cost,
2. native hot swapping,
3. faster data transfer through higher signalling rates, and
4. more efficient transfer through an (optional) I/O queuing protocol.

The SATA standard defines a data cable with seven conductors (3 grounds and 4 active data lines in two pairs of conductors) and 8 mm wide wafer connectors on each end. The three grounding wires dampen any crosstalk. A SATA cable can have a length up to 1 metre (3.3 ft), and connects one motherboard socket to one hard drive.

SATA revision	Bandwidth (Coded)	Bandwidth (Actual)	Year
1.0	1.5 Gbit/s	1.2 Gbit/s (150MB/s) *	2003
2.0	3 Gbit/s	2.4 Gbit/s (300MB/s) *	2005
3.0	6 Gbit/s	4.8 Gbit/s (600MB/s) *	2009

* 8b/10b encoding

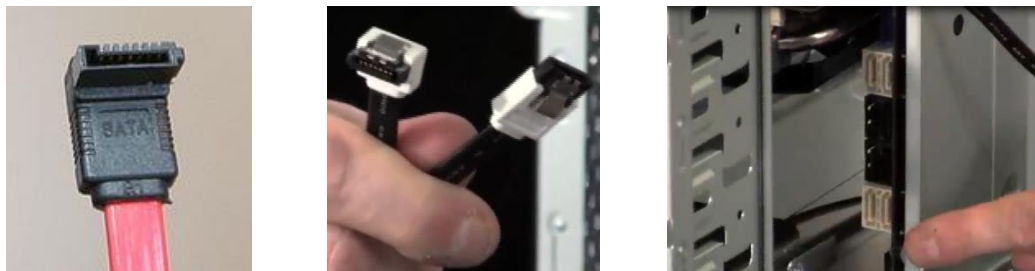

Pin #	Mating	Function
1	1st	Ground
2	2nd	A+ (Transmit)
3	2nd	A- (Transmit)
4	1st	Ground
5	2nd	B- (Receive)
6	2nd	B+ (Receive)
7	1st	Ground

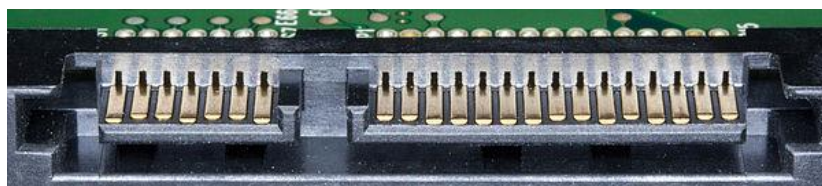

Figure: *Left* The 7-Pin SATA data cable (angled end); *Middle* The SATA data cable (angled and straight ends); *Right* The SATA connectors on the motherboard (straight); *Below Left* The SATA Data connector Pinout; *Below Right* The SATA connector on a hard drive (7 pin data connector on the left and 15 pin power connector on the right). Pins are spaced 1.27mm apart.

References:

1. Asus (2014) *Thermal Armor Total Airflow-Boosting Circulation Test*
http://www.asus.com/Motherboards/SABERTOOTH_Z77
2. Eastaugh, Matthew, (2004) *Micro processor Tutorial*:
<http://www.eastaughs.fsnet.co.uk/cpu/structure-reg.htm>
3. HowStuffWorks (2014) A useful site for various computer articles, images and video. <http://computer.howstuffworks.com>
4. Intel (2014a) *Desktop Boards Power supply considerations for building a computer*, <http://www.intel.com/support/motherboards/desktop/sb/CS-008646.htm>
5. Intel (2014b) Intel® Desktop Board DZ77BH Interactive Layout
<http://www.intel.com/content/www/us/en/desktops/desktop-board-dz77bh-55k-interactive-layout-demo-video.html>
Mouse over the 40 numbered items to see feature descriptions.
6. Intel (2014c) For a 360° view of the z77 motherboard
<http://www.intel.com/content/www/us/en/desktops/desktop-board-dz77bh-55k-360view-demo-video.html>
Move your mouse across the board image to rotate it.
7. Intel (2014d) Block Diagram of the Intel Z77 Express Chipset
<http://www.intel.com/content/dam/www/public/us/en/documents/product-briefs/z75-z77-express-chipset-brief.pdf>
8. Intel (2014e) Port 80h POST Codes Ranges, the operation that corresponds to the code and the POST sequence <http://www.intel.com/support/motherboards/desktop/sb/CS-025434.htm>
9. Mueller, Scott (2013) *Upgrading and Repairing PCs*, 21th Edition, Que Publishing, Indianapolis.
10. Nvidia (2014) Technology demos from Nvidia used to showcase the rendering power of the chip. See YouTube and <http://www.nvidia.com/coolstuff/demos>
11. Tweaktown (2014) This link has some good images of the z77 motherboard:
<http://www.tweaktown.com/reviews/5259/gigabyte-z77-hd4-intel-z77-motherboard-review/index2.html>
12. Tennis, Caleb (2009) *A Peek At Computer Electronics*, The Pragmatic Programmers LLC.
13. White, Ron (2008) *How Computers Work*, 9th Edition, Que Publishing, Indianapolis.
14. HowStuffWorks (2014) A useful site for various computer articles, images and video.
15. PCI Express SIG site. <https://www.pcisig.com/home>
16. Serial ATA website. www.serialata.org